

9157 MOBO® 19 Way I/O Connector



GENERAL DESCRIPTION

Based on our standard 15 way 9157 I/O family, AVX has now released a family 19 way devices. This range includes a SMT 90 degree plug, a wire socket version that is used with the standard 9157 cover and a SMT socket for charging applications.

Options with the 90 degree SMT socket include the sealing of the connector contacts and the connector to the housing up to IP67. There is also an option to have an EMLB (early mate, late break) on pins 1 and 19.

To achieve the seal to the device housing, it may be necessary to customize the device housing design.

On the SMT 90 degree version, we also have the capability of an integrated DC jack, enabling both the DC jack and the 19 way cover to be plugged in at the same time.

AVAILABLE DEVICES:

10 9157 019 000 006	Plug wire version
10 9157 019 000 007	SMT charging version
20 9157 019 000 006	90 degree SMT socket
30 9157 97 XX 00 000	Cover options see page 23

Cover Kit

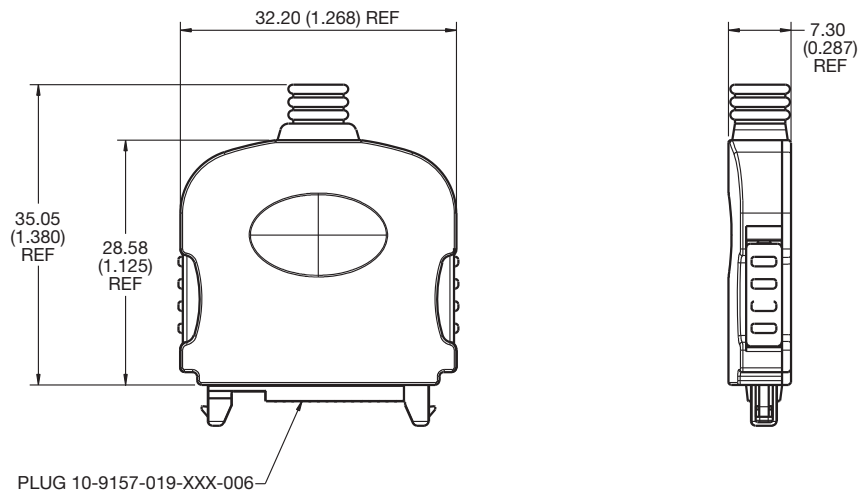

9157 MOBO[®] 19 Way I/O Connector



Plug Wire

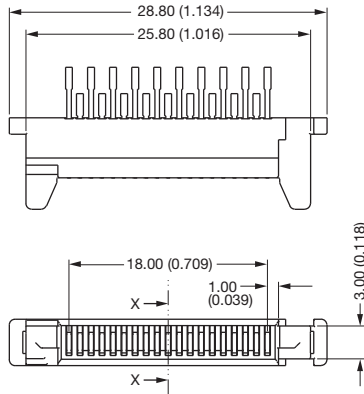

SMT Plug

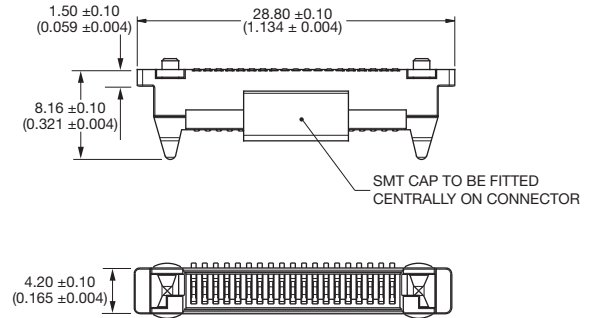

SMT Socket

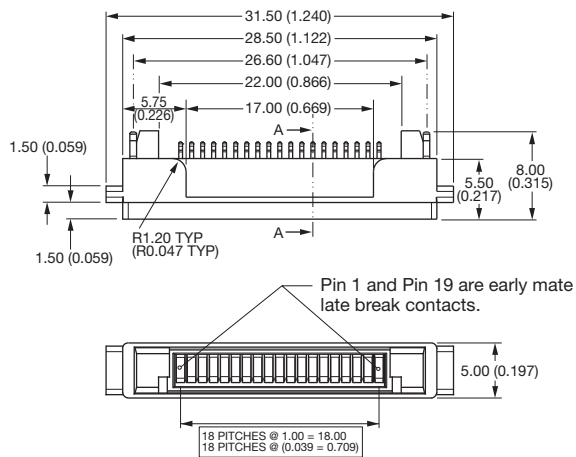

SMT Plug (Suggested PCB Layout)

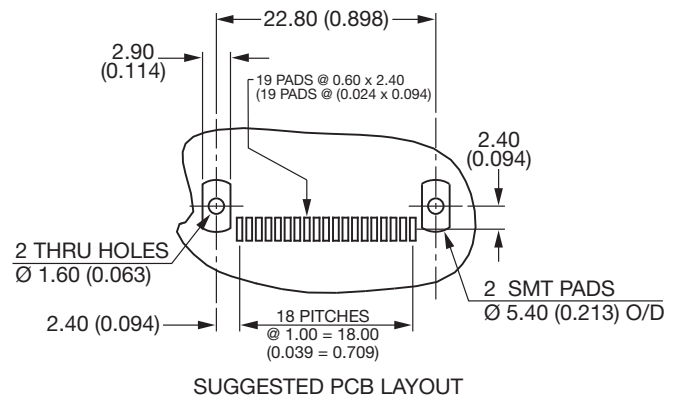

SMT Socket (Suggested PCB Layout)

